

ad | tech

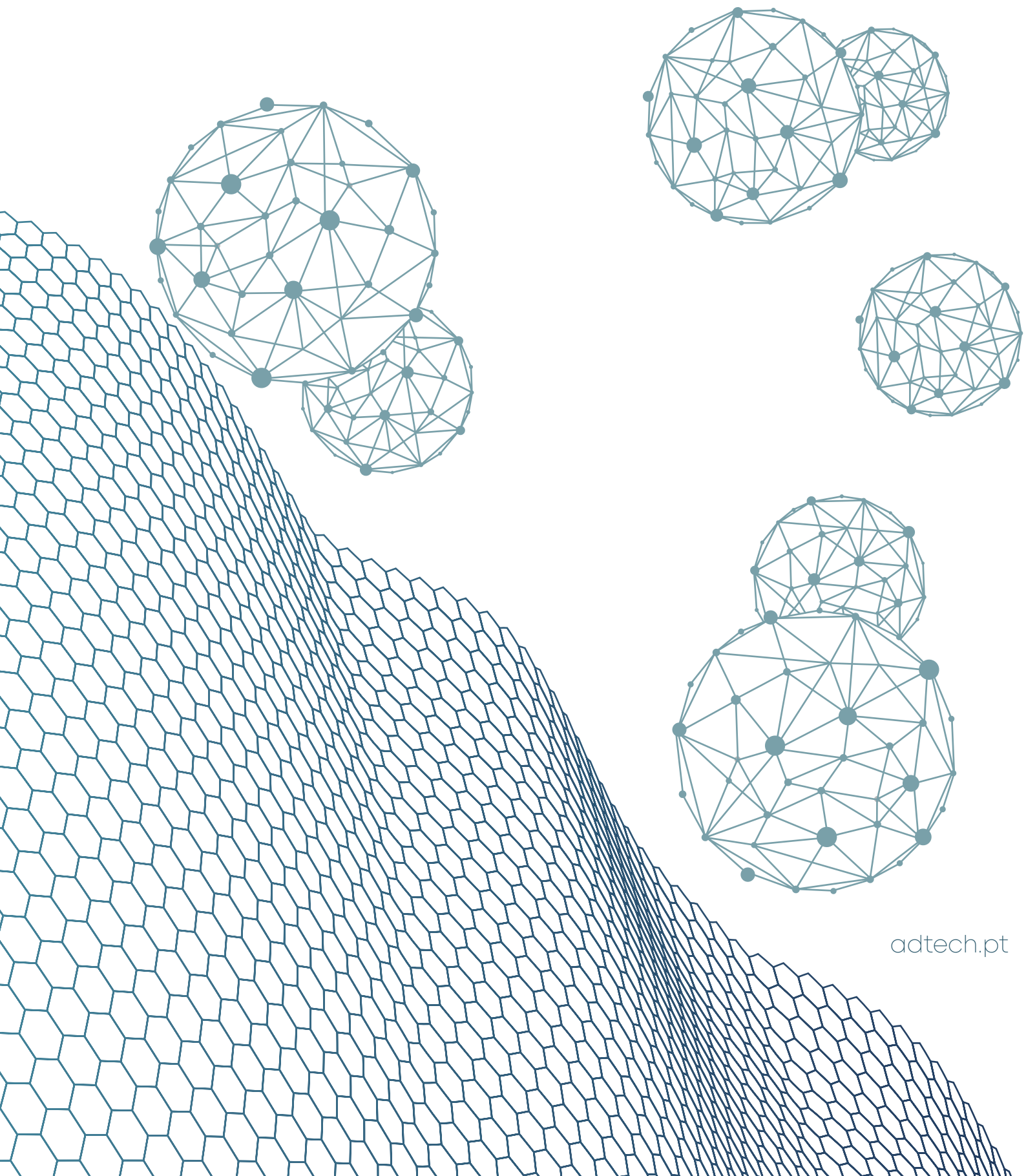

adtech.pt



GENERAL PRODUCT CHARACTERISTICS

ADTECH's protect line comprises of a set of cleverly designed garments, aimed specifically to the general population to allow them to have a strong layer of protection when resuming their daily activities. The current pandemic will have long lasting effects on global societies and new segments for visually appealing protective wear will be created. This should be the first protective wear line in the market to combine design, functionality and technology and should set the trend for years to come.

All technologies and components used in our range are certified in terms of its claimed efficiency, are individually registered in the EU and are compliant with all European Union norms and regulations.

The entire range was created with four layers of safety in mind that work simultaneously to minimize the probabilities of contamination.

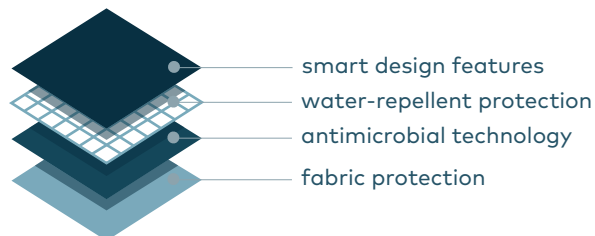

All the decisions taken during the construction of the product were aimed at maximizing safety and long-term comfort for the end user.

These combinations are registered property and are currently undergoing testing against SARS-CoV-2 by an accredited and independent lab. Any change in the combinations or formulations will void the utilization of any possible viral claims.

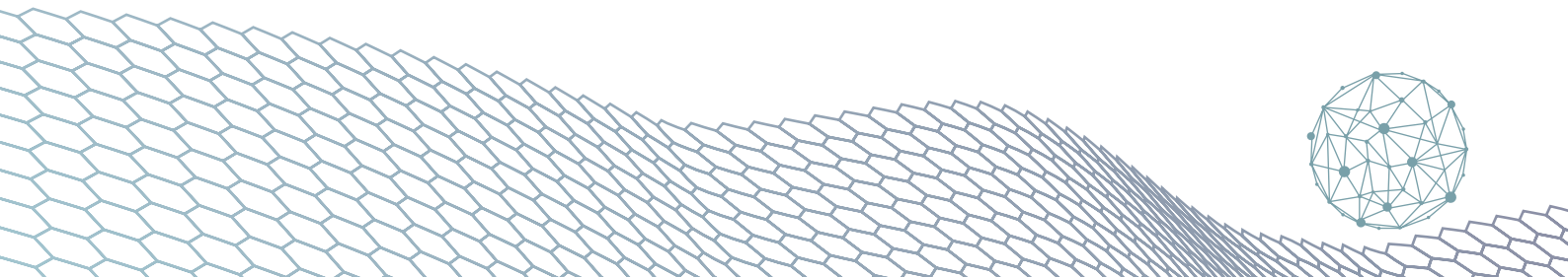



Anti-microbial functionality

Contrary to most products found in the market that eliminate microbes using heavy particles and induce bacterial poisoning, our mechanism of microbe elimination works by electrical attraction and mechanical interruption (puncturing) of the cell wall. Our technology significantly reduces the likelihood of the development of bacterial resistance and remains effective for a long period of time.

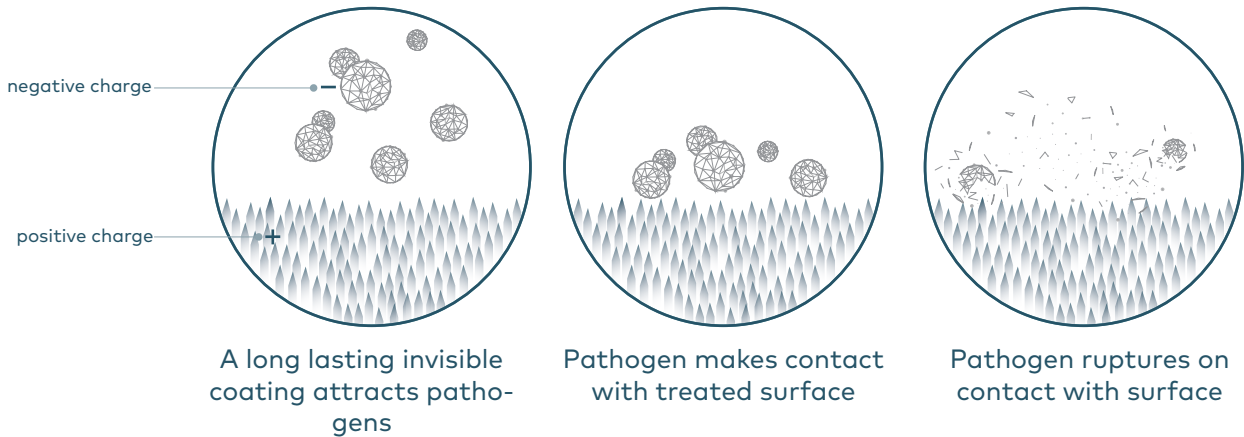

Washes and Durability

The technology used is highly resistant to washing, maintaining an efficiency level greater than 99% even after dozens of domestic washes, remaining functional throughout the product's useful life.

We are claiming 95% efficiency on bacterial reduction after 50 domestic washes.

The bond created by the active ingredient and the fabric is extremely strong and does not dissolve in water.

Contrary to the common anti-bacterial agents that work via poisoning, our active ingredient is not consumed by the microbes lasting for much longer than alternatives.

Water Repellency

Additionally, a water-repellent treatment equivalent to one used in hospital products was added to the masks, face covers and gloves in an effort to provide a strong, additional layer of protection.

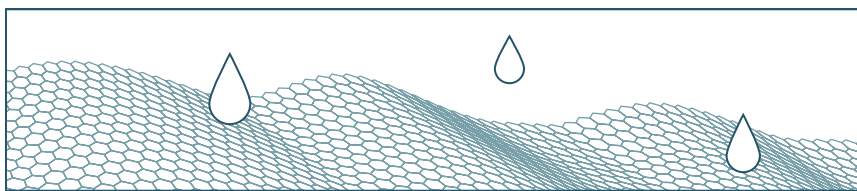

One of the main means of aerial viral transport is through small water droplets or aerosols. The protective factor added to the masks and gloves allows the outer layer of the fabric to be used as a strong invisible repellent barrier, increasing the probability of harmful droplets being repelled preventing its attachment to the textile's surface.

User movement or air friction is sufficient to repel any droplets that may be in contact with the textile substrate.

Our product is Oeko-tex and REACH registered and therefore compliant with European regulation.





High density polymer for user comfort

Another important technology included in all products is the application of a high-density polymer, that when applied to the textile substrate creates an effective and intelligent moisture management system that will improve moisture distribution and allow for faster and more efficient drying process.

This application is conceived to generate a pleasant, silky feel that increases the value of the garment to the end consumer.

The concentration in use of the high-density polymer increases not only color retention, but also the fabrics ability to recover from stretching. This ensures the garment will retain its color and fit even after several washing cycles and prolonged utilization.

This polymer is biodegradable and is certified by Bluesign, Oeko-tex and REACH.

Product and producer Certifications

Adalberto has the following certifications:

- Oeko tex 1001
- Sedex
- Iso 9001
- BCI
- GOTS
- Global Recycled Standard
- Organic 100



Final certifications for the product are pending, however the product has already been granted a seal of conformity from CITEVE as a social mask level two, as well as an Oeko-Tex certificate. Other certifications may follow.

Product complies with all European legislation and REACH.

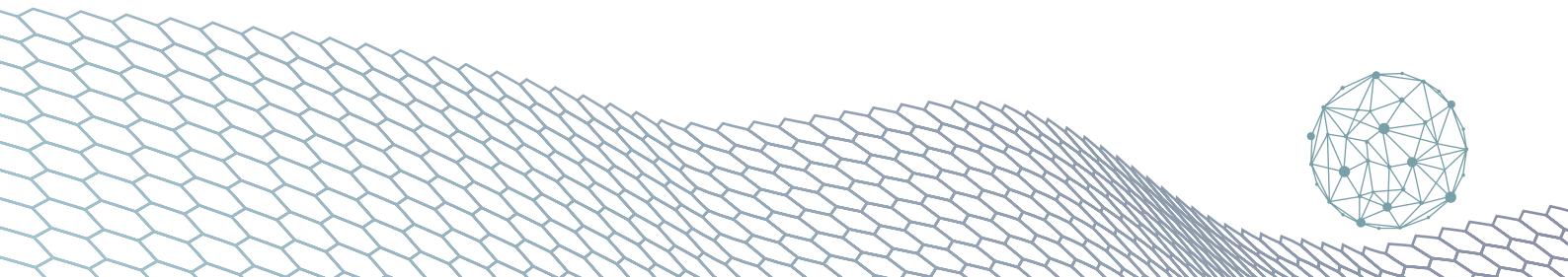



What is a microbe?

Microorganisms or microbes are microscopic organisms that exist as unicellular, multicellular, or cell clusters. Microorganisms are widespread in nature and are beneficial to life, but some can cause serious harm. They can be divided into six major types: bacteria, archaea, fungi, protozoa, algae, and viruses.

What is a bacteria?

Bacteria are single celled microbes. The cell structure is simpler than that of other organisms as there is no nucleus or membrane bound organelles. Instead their control center containing the genetic information is contained in a single loop of DNA.

What is a virus?

A microorganism that is smaller than a bacterium that cannot grow or reproduce apart from a living cell. A virus invades living cells and uses their chemical machinery to keep itself alive and to replicate itself. It may reproduce with fidelity or with errors (mutations).

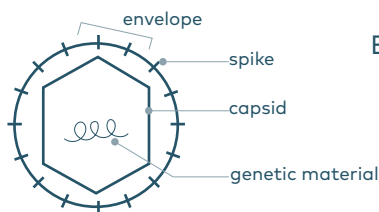

Enveloped virus: have a lipid layer

- uses the "spikes" to attach to the host for multiplication
- easier to kill by interference with the lipid layers
- examples: influenza, 1HN1, SARS-CoV-2, Ebola, etc

Why use the water repellent?

Water repellency technology is being used to repel and avoid droplets of water to burst upon contact with the treated surface and to prevent its subsequent release of organic material on surfaces close to the face of the consumer.

What is a non-migratory technology?

It is a technology that does not leave the textile substrate upon usage or washing.

How effective is the product?

The combination of smart design, formulation and technologies acts as formidable protection barrier, above and beyond any other product available in the market for the general population.

The product is engineered to avoid microbial contamination and designed to act and eliminate threats in the scenario of fabric contamination.

The product will reduce the risk of transporting active bacteria and virus from the exterior to consumers houses as well as from person to person.





Can we claim the product kills virus?

Laboratorial results indicate that our fabrics (AD-PROTECT) treated with our active ingredients are effective in the inactivation of viruses. Tests were performed according to the official ISO viricidal test standard.

Can we wash the product?

Yes. Repeatedly.

All products are engineered to be washed at low temperatures and without the need for fabric softener. We want the users to protect their garments and the environment.

Should the product be stored in any special form?

There is no need for special storage of any of the products.

For how long is the product effective?

Studies demonstrate similar effects throughout time. There is no indication time plays any significant role in the degradation of the protective qualities of the product.

Is this product aimed for medical professionals?

The product was constructed with the validation and counseling of several medical doctors with different specialties and backgrounds. It can be used by doctors but it is not engineered to comply with medical regulation, nor to be used as their workwear.

Are the masks on offer certified?

On direct comparison terms, our mask offers several protection systems compared to the standard of particles retention measured in most international norms.

An independent, certified lab, certified our product as a level 2 social mask. We have a score of 95% of particle retention with a diameter greater than 3µm, according to the norm MI 142-CITEVE.

We also have measurements of the masks breathability with certified results of 9,8L of air per minute. The result falls within internationally accepted parameters according to the test norm EN ISO 9237:1995.

There is little regulation or norms regarding masks with particle repellency and microbial protection as we offer.





protective mask

Product

Our mask offers several layers of protection against possible contamination.

The first layer to come into contact with a potentially contaminated element is the repellency system, designed to immediately disperse droplets and avoid them to burst and release organic material in the external layer of the mask.

The second protection layer is the high concentration of proven antimicrobial technology that covers the outer layers of the mask.

The third and fourth layers to act are related to its inherent composition. The two sheets of technical fabric, chosen by its inherent filtering properties and bi-stretch technology acts as a defense mechanism, and the filter contained inside every mask offers equivalent particle retention to several off the shelf disposable masks.

The inner layer of the mask, designed to be in contact with the users mouth and nose, is not treated or covered with any chemicals other than the non-migrating antimicrobial technology and moisture management. It will regulate moist and avoid smells, but will not contain any dyes or reagents of a colored item.

The mask is constructed out of a bi-stretch technical fabric containing 80% polyester and 20% elastane. It is covered by an elastic tape that can be personalized and that will allow for further user adjustability. It is designed for prolonged usage.

The mask can be washed at low temperatures on short cycles. Studies demonstrate that simply hanging the mask under sunlight for a period superior to four hours eliminate all microorganisms present in the mask.

Independent testing demonstrated that our mask averaged 95% retention of particles with a diameter greater than 3µm, according to the norm MI 142-CITEVE, as well as qualified within accepted breathability parameters according to the norm EN ISO 9237:1995.



high grade water-repellent protection

minimizes the risk of virus and bacteria clinging to neck and face cover

moisture management

enhanced breathability balancing humidity and temperature levels

technical fabric

with excellent combination of breathability and particle retention



odour control

prevents growth and development of bacteria associated with unpleasant odours

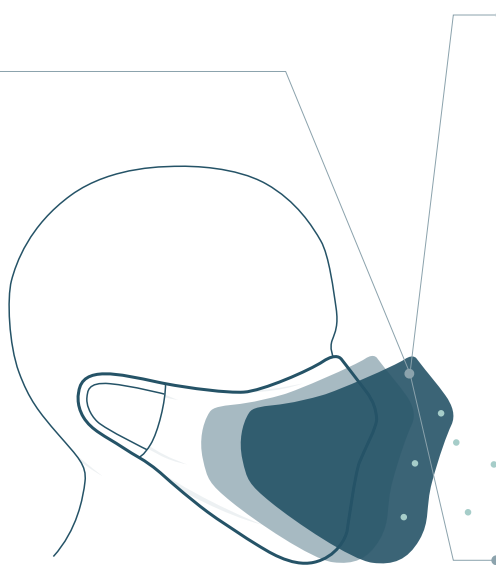

shield against cross contamination of virus and bacteria

may reduce viral activity of enveloped viruses



non stop antimicrobial protection

permanent technology that destroys broad spectrum of bacteria, fungi and algae



non toxic and skin safe

engineered with tested and certified products according to the highest standards of European Union regulation

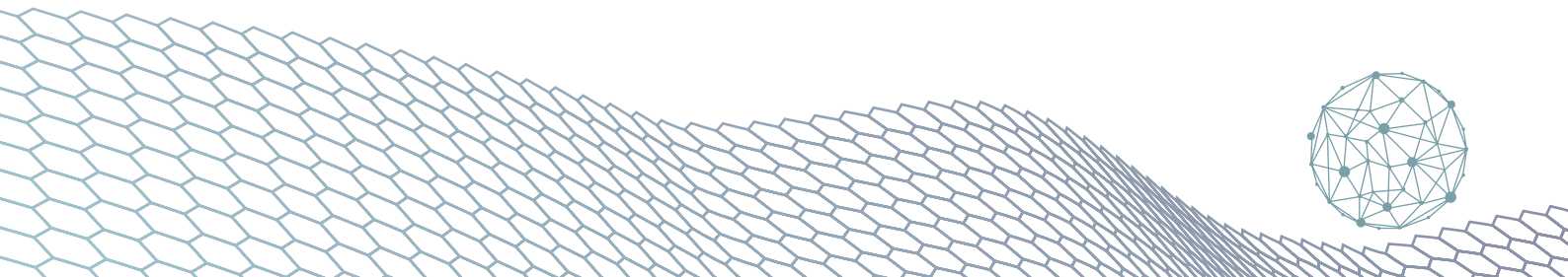

Product Specifications

washable mask

Features multiple layers of protection



shield against cross contamination of virus and bacteria

reduces viral activity on enveloped viruses



non stop antimicrobial

permanent technology that destroys broad spectrum of bacteria, fungi and algae



high grade water-repellent protection

minimizes the risk of virus and bacteria clinging to neck and face cover



odour control

prevents growth and development of bacteria associated with unpleasant odours



technical fabric

with excellent combination of breathability and particle retention



moisture management

enhanced breathability balancing humidity and temperature levels

Certified as level 2 Mask

With ad | protect® (unique technology that protects against virus, bacteria, fungus and algae)
 Norm **MI 142-CITEVE** (based on values EN 14683:2019), 95% retention of particles
 Norm **EN ISO 9237:1995** certified within accepted breathability parameters

by

- CITEVE (Centro Tecnológico Têxtil e Vestuário)
- Ministerio da Saúde
- DGS (Direção Geral da Saúde)
- INFARMED
- Instituto Português Qualidade



antiviral protection being tested by IMM Instituto de Medicina Molecular

	ad-tech protect mask	FFP2/N95 respirator	surgical mask	textile fabric mask
purpose	-shields user from air pollution, dust, bacterial and pollen allergy. -antimicrobial coating shields against virus and bacteria. -prevents user from touching face and nose. -provides safety and comfort for long periods of time	-for disposable medical use -reduces inhale of small aerosols and large particles -helps user from touching face and nose.	-for disposable medical use -reduces inhale of large particles and body fluids -helps user from touching face and nose.	-helps users from touching face and nose.
anti-microbial (virus, bacteria, fungus)	✓	✗	✗	✗
longevity	>1 year*	8 to 21 hours	up to 4 hours	depends on material
reusable & washable	✓	no. single use	no. single use	✓
filtration PM3.0 (particle retention)	✓ 95%, tests based on MI 142-Citeve	✓ >=95%	✗	✗
water droplets repellency	✓	✗	✗	✗
nose clip	✓	✓	✗	✗

*considering 1 year with weekly wash

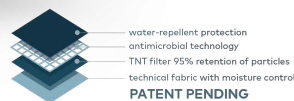

Adalberto's Certifications



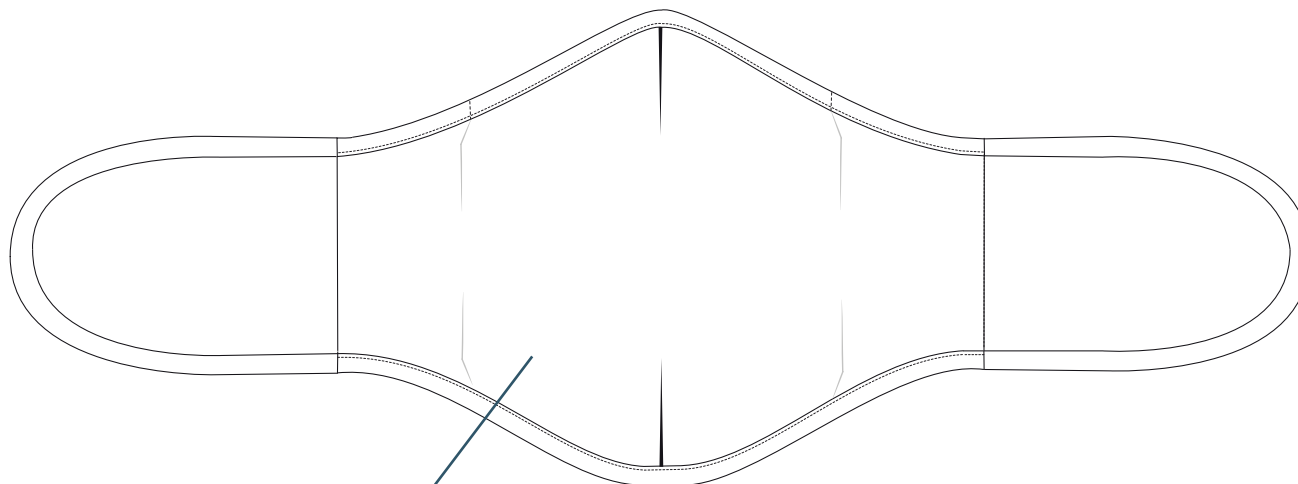

Outside view

TRANSFER MASK:
placed on the inside

ad i tech
designed to protect

MADE IN PORTUGAL

80% poliéster 20% elastano
80% polyester 20% eslatane
80% poliéster 20% elastano
80% polyester 20% élasthanne

adtech.pt

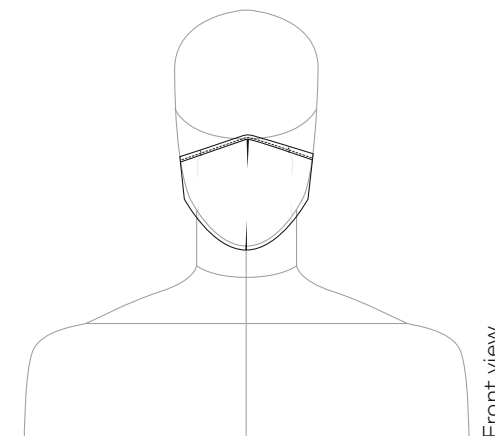

Front view

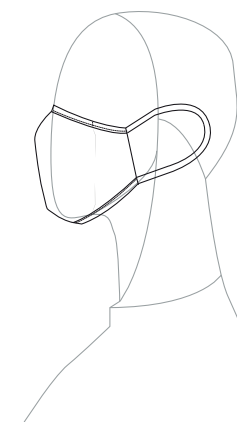

Side view

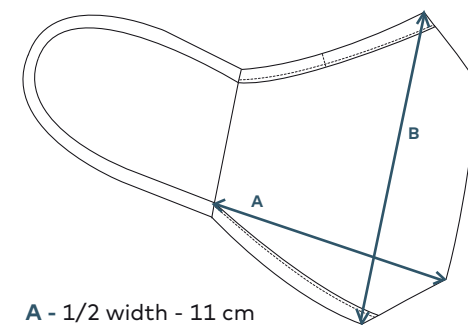

A - 1/2 width - 11 cm
B - Total height - 15,5 cm

Image 1/2 mask

// MASK AD - PROTECT P

Outer layer - Polyester with repellent and anti - microbial finishing
Inner layer - Moisture and odor manager



ad | tech social mask

product

this product was created with the purpose of adding an extra layer of protection to your daily life without compromise your comfort.

it was designed to be used for long periods of time with comfort and safety.

the facial protection system was made with a technology that repels water particles and other organic materials creating an invisible layer that helps keep you protected.

recommendations

this product was developed with the most advanced textile technologies available on the market in order to protect users from microbial contamination.

this product contains technologies that allow it to be used in a hospital environment, however it is not a medical device, doesn't comply with the regulation of surgical masks (regulation EU / 2017/745) or protective equipment individual (regulation EU / 2016/425)

it shouldn't be used for that purpose.

there is no way to guarantee that users of this product can't suffer microbial contamination.

it's recommend to have the maximum precaution as possible, this product does not replace hygiene measures.

follow the rules and recommendations of government and health authorities.

instructions for users

this mask should be used as a complement to the recommended protection and hygiene measures and to the rules of social distance, which are essential for the control of COVID-19. For more information, see <https://covid19.mini-saude.pt>.

the reusable mask must be handled correctly.

the following instructions are recommended for the correct use of the mask, according to the DGS Guideline (nº019 / 2020 of 03/04/2020):

- a) do the hand hygiene, with soap and water or an alcohol-based solution, before putting on the mask;
- b) placing the mask with the inner part of the mask facing the face, and the outer facing out;
- c) adjust the rigid end of the mask to the nose, the mask should cover the mouth, nose and chin, make sure that there are no open spaces between the face and the mask;
- d) do not touch the mask while in use; if this happens, hand hygiene must be performed immediately;
- e) it is recommended to use each mask for a maximum period of 4 hours a day, and the mask should be replaced with a new one at the end of that period or as soon as it's wet.

the removed mask must be washed before being reused;

f) if you accidentally wet the mask, replace it with a dry one as soon as possible. The wet mask must be washed before being reused;

g) the removal of the mask must be done from the back part of the mask (not touching the front part), holding the ties or elastic bands;

h) the mask must be placed individually in a closed plastic bag, until placing it on washing machine;

i) new hand hygiene must be performed at the end of the use or handle of the mask.

the mask must be washed before reuse it,

mask protection is only guaranteed if you follow the cleaning and care instructions that follows.

the mask must comply the minimum number of 5 wash cycles.

the mask must be stored in a dry environment and protected from potential contamination.

the mask must be washed before the first use.

in case of defect or damage do not use the mask, replace it with another one.

at the end of the mask's life cycle, wash the mask under the conditions defined in the "conservation and cleaning" section and after washing it must be discarded as non-hazardous textile waste.

if you choose not to wash the mask you should discard it as biological waste.

conservation and cleaning

after each use, the masks should be washed with a complete, normal washing cycle at 60 ° C with detergent, the user must ensure that the mask is dry before use.

mask category

level 2: masks made to be used by non-health professionals that contact with a large number of individuals.

maximum number of washing cycles in which the protective performance of the mask is guaranteed

5 washes

exemplary mask placement pictogram

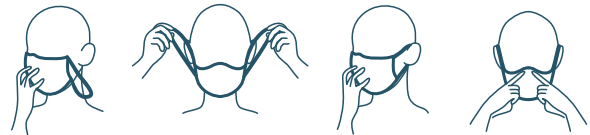

exemplary mask removal pictogram



washing instructions



inner and out side identification

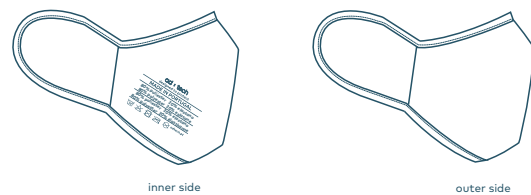

composition

textile interior:
80% polyester
20% spandex

filter:
100% polypropylene

made by

adalberto

adress

Adalberto Pinto da Silva, nº28
4795-177 Rebordões Portugal

trade mark

ad | tech

lot number: 000250047212
compliance verified through the report "CITEVE nº 4278/2020"

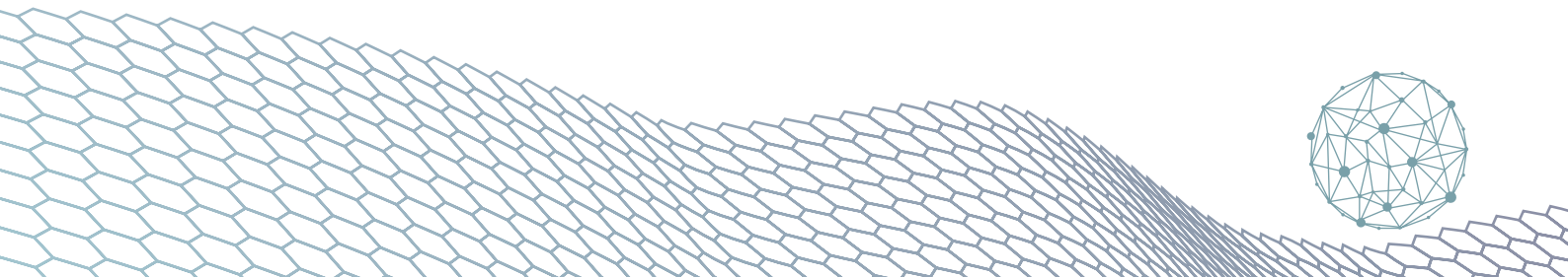

LABORATÓRIOS - V.N.FAMALICÃO



À Firma

ESTAMPARIA TÊXTIL ADALBERTO PINTO DA SILVA, S.A.
RUA ADALBERTO PINTO DA SILVA, Nº 28

4795-177- REBORDÕES - STO TIRSO

Entrada: 5624/2020

Data de Recepção das Amostras : 2020/04/30

Observações

Grupos de Ensaios

Máscaras cirúrgicas -Ficha técnica CITEVE 1/04/2020

N. Amostras - V/Referência

8499/2020 - AD-Protect-P Mask V1-Preta

8507/2020 - AD-Protect-P Mask V1- Estampada

Ensaios Requeridos

Ensaios físicos

- Os ensaios foram realizados entre a data 2020/04/30 e 2020/05/06.

V.N.FAMALICÃO, 07 de Maio de 2020

COORDENADOR
DO LABORATÓRIO

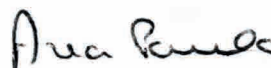

(Eng^a Ana Paula Fonte)

NOTAS:

- Os resultados deste relatório foram obtidos segundo os procedimentos descritos no manual da Qualidade do CITEVE e referem-se apenas às amostras submetidas a ensaios, acima referenciadas.
- O relatório de ensaios não pode ser parcialmente reproduzido sem autorização do CITEVE.
- Os ensaios assinalados com * não estão incluídos no âmbito da acreditação deste laboratório
- l.q - limite de quantificação l.d. - limite de detecção n.d. - não detectado
- As amostras são armazenadas durante 6 meses, após a data de entrada, com exceção dos produtos químicos que são armazenadas por um mês.

LABORATÓRIOS - V.N.FAMALICÃO

<u>No. da Amostra</u>	<u>V/ Referência</u>	<u>Descrição da Amostra</u>
8499 /2020	AD-Protect-P Mask V1-Preta	1 máscara

Ensaio/Norma: PERMEABILIDADE AO AR / EN ISO 9237:1995

Resultados

Valor médio (l/(m ² .s) ou mm/s):	93,2
C.V. (%)	6,5
I.C. (95%)	± 18,3
Caudal médio de ar (l/min):	11

Requisitos mínimos:

- Superior ou igual a 8 l/min

Nota: Os valores de requisitos mínimos são baseados na caracterização de máscaras cirúrgicas certificadas pela norma EN 14683: 2019 tipo I

Condições de Ensaio

Número de provetes testados - 2

Área testada - 20 cm²

Pressão utilizada (Pa) - 40

Ambiente condicionado:

20+/-2°C e 65+/-4% H.R.

Ensaio/Norma: * AVALIAÇÃO DA RETENÇÃO DE PARTÍCULAS / MI 142/00

Resultados

PRC (superior ou igual a 3 µm) (%) -	96
PRC (0,5 µm a 0,7 µm) (%) -	38

Requisitos mínimos:

Máscaras nível 2, tipo I (cirúrgica):

PRC (superior ou igual a 3 µm)

- Superior ou igual a 95%

PRC (0,5 µm a 0,7 µm)

- Superior ou igual a 35%

Máscaras nível 2, para profissionais em contacto com o público:

PRC (superior ou igual a 3 µm)

- Superior ou igual a 90%

Máscaras nível 3, para população em geral:

LABORATÓRIOS - V.N.FAMALICÃO

PRC (superior ou igual a 3 μm)
- Superior ou igual a 70%

Nota: Os valores de requisitos mínimos são baseados na caracterização de máscaras cirúrgicas certificadas pela norma EN 14683: 2019 tipo I

Condições de Ensaio

Velocidade do ar: 28,3 l/min

Tempo de ensaio: 1 min

MPS: 0,6 μm a 0,7 μm

PCR= capacidade de retenção de partículas (%)

MPS= tamanho médio de partículas

<u>No. da Amostra</u>	<u>V/ Referência</u>	<u>Descrição da Amostra</u>
8507 /2020	AD-Protect-P Mask V1- Estampada	1 máscara

Ensaio/Norma: PERMEABILIDADE AO AR / EN ISO 9237:1995

Resultados

Valor médio (l/(m ² .s) ou mm/s):	92,6
C.V. (%)	2,7
I.C. (95%)	± 7,5
Caudal médio de ar (l/min):	11

Requisitos mínimos:
- Superior ou igual a 8 l/min

Nota: Os valores de requisitos mínimos são baseados na caracterização de máscaras cirúrgicas certificadas pela norma EN 14683: 2019 tipo I

Condições de Ensaio

Número de provetes testados - 2

Área testada - 20 cm²

Pressão utilizada (Pa) - 40

LABORATÓRIOS - V.N.FAMALICÃO

Ambiente condicionado:
20+/-2°C e 65+/-4% H.R.

Ensaio/Norma: * **AVALIAÇÃO DA RETENÇÃO DE PARTÍCULAS / MI 142/00**

Resultados

PRC (superior ou igual a 3 µm) (%) -	98
PRC (0,5 µm a 0,7 µm) (%) -	49

Requisitos mínimos:

Máscaras nível 2, tipo I (cirúrgica):

PRC (superior ou igual a 3 µm)

- Superior ou igual a 95%

PRC (0,5 µm a 0,7 µm)

- Superior ou igual a 35%

Máscaras nível 2, para profissionais em contacto com o público:

PRC (superior ou igual a 3 µm)

- Superior ou igual a 90%

Máscaras nível 3, para população em geral:

PRC (superior ou igual a 3 µm)

- Superior ou igual a 70%

Nota: Os valores de requisitos mínimos são baseados na caracterização de máscaras cirúrgicas certificadas pela norma EN 14683: 2019 tipo I

Condições de Ensaio

Velocidade do ar: 28,3 l/min

Tempo de ensaio: 1 min

MPS: 0,6 µm a 0,7 µm

PCR= capacidade de retenção de partículas (%)

MPS= tamanho médio de partículas



Technical Report

Devan Report Reference : 14212

Date : 06/05/2020

Customer Project Number : 7413

Antimicrobial Test Results

Black	Microbiological Analysis Bacterial [1] (% reduction)	Pass/Fail [3]
80% PES/20% Ea	24hrs	
Untreated	0,0	
Treated 50xW60°C	99,99	PASS

Conclusions:

The samples treated with [redacted] show significant bacterial reduction before and after 50xW60°C. These samples pass the [redacted] quality control standards and criteria.

This project has been approved by :

Devan Lab
Devan Chemicals

[1] ASTM E2149-13 "Dynamic Shake Flask": 1g sample, 50ml 0.3 mM KH₂PO₄, 1x10⁵ E.coli/ml, 0.01% Q2-5211 Wetting Agent

[2] Blue Test: BPB Extraction: 1.0 g sample weight, 0.001% BPB dH₂O solution, 20 minutes exposure, 595 nm Absorbance, 0.01% Q2-5211 Wetting Agent

[3] Pass/Fail: Based on the [redacted] Quality Assurance Standards



The information contained in this test report is the result of our research and experience. It is given in good faith, but under no circumstances does it constitute a guarantee on our part, nor does it hold us responsible, particularly in the case of legal action by a third party.

© Devan Chemicals 2017





LABORATÓRIOS - V.N.FAMALICÃO

<u>No. da Amostra</u>	<u>V/ Referência</u>	<u>Descrição da Amostra</u>
7521 /2020	Refª Tecido Máscaras Exterior	1 amostra de Tecido

Ensaio/Norma: RESISTÊNCIA À MOLHAGEM SUPERFICIAL (ENSAIO DO CHUVEIRO) / ISO 4920:2012

Resultados

Valores Individuais	ISO 3
	ISO 3
	ISO 3

Condições de Ensaio

Temperatura da água - 20±2°C
Ambiente condicionado:
20+/-2°C e 65+/-4% H.R.



Moisture Management Test

Our moisture management technology works by providing an ultrafine polymer coating to the fibre surface.

The coating provides a means to wick moisture from the skin surface and disperse it over a large surface area to promote efficient evaporation from the textile surface.



Above is a demonstration of the efficiency of the technology. Further testing is currently being conducted to showcase inside layer's capability to disperse and manage moist.

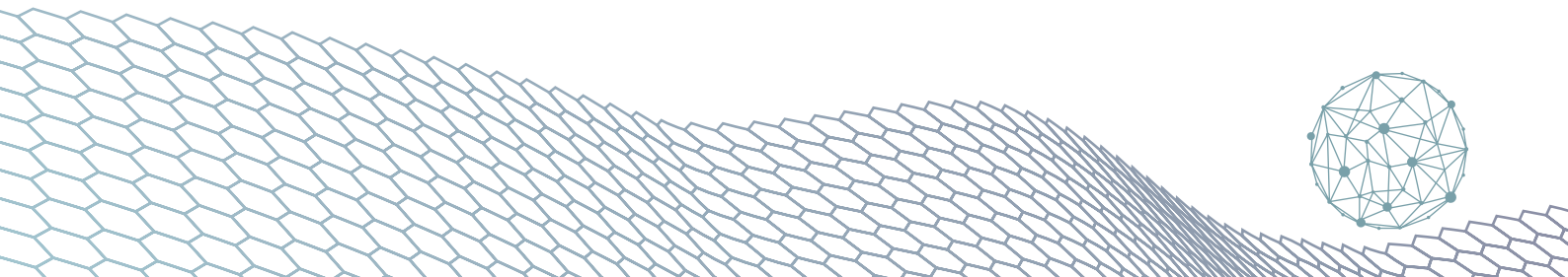

DECLARAÇÃO DE CONFORMIDADE



A empresa

**ESTAMPARIA TÊXTIL ADALBERTO PINTO
DA SILVA, S.A.
RUA ADALBERTO PINTO DA SILVA, Nº 28
4795-177 REBORDÕES - STO TIRSO
PORTUGAL**



5 LAVAGENS USO PROFISSIONAL (NÍVEL 2)

está autorizada, por esta declaração de conformidade, emitida de acordo com o documento **“Máscaras destinadas à utilização no âmbito do COVID-19 – Especificações Técnicas”** publicado pela **DGS, INFARMED, ASAE e IPQ** a 14 de abril de 2020 e baseada no relatório de ensaio nº **4278/2020**, a utilizar o selo **“Máscaras COVID-19 Aprovado”**

para o seguinte artigo:

AD-PROTECT-P MASK V1

Os resultados dos ensaios realizados comprovam que o artigo cumpre os requisitos mínimos relativamente à respirabilidade e capacidade de filtração para máscaras utilizadas no contexto do **COVID-19 Nível 2 - Máscaras de Uso Profissional (5 lavagens)**.



Esta máscara pretende servir como uma máscara barreira para complemento das medidas de proteção e das regras de distanciamento social, não se podendo nunca sobrepor às medidas de proteção e das regras de distanciamento social, fundamentais para controlo da COVID-19.

Adicionalmente, estas máscaras não são para utilização por profissionais de saúde no exercício das suas funções, nem são um dispositivo médico e não cumprem o regulamento das máscaras cirúrgicas (Regulamento UE/2017/745), nem dos EPI (Regulamento UE/2016/425).

O beneficiário desta declaração está obrigado através da assinatura da declaração de compromisso a utilizar a marca COVID-19 somente em produtos que estão em conformidade com a amostra ensaiada.

Vila Nova de Famalicão, **22-4-2020**

O Director dos Laboratórios
Maria Antónia Lopes

DECLARAÇÃO DE CONFORMIDADE

A empresa

**ESTAMPARIA TÊXTIL ADALBERTO PINTO
DA SILVA, S.A.
RUA ADALBERTO PINTO DA SILVA, Nº 28
4795-177 REBORDÕES - STO TIRSO**



MATÉRIA-PRIMA PARA MÁSCARAS NÍVEL 2

está autorizada, por esta declaração de conformidade, emitida de acordo com o documento **“Máscaras destinadas à utilização no âmbito do COVID-19 – Especificações Técnicas”** publicado pela **DGS, INFARMED, ASAE e IPQ** a 14 de abril de 2020 e baseada no relatório de ensaio nº **3565/2020**, a utilizar o selo **“Máscaras COVID-19 Aprovado”**

para o seguinte artigo:

ADSTYLE I

Os resultados dos ensaios realizados comprovam que o artigo cumpre os requisitos mínimos relativamente à respirabilidade e capacidade de filtração para máscaras utilizadas no contexto do **COVID-19 Nível 2 - Máscaras de Uso Profissional**.

Estas máscaras pretende servir como uma máscara barreira para complemento das medidas de proteção e das regras de distanciamento social, não se podendo nunca sobrepor às medidas de proteção e das regras de distanciamento social, fundamentais para controlo da COVID-19.

Adicionalmente, estas máscaras não são para utilização por profissionais de saúde no exercício das suas funções, nem são um dispositivo médico e não cumprem o regulamento das máscaras cirúrgicas (Regulamento UE/2017/745), nem dos EPI (Regulamento UE/2016/425).

O beneficiário desta declaração está obrigado através da assinatura da declaração de compromisso a utilizar a marca COVID-19 somente em produtos que estão em conformidade com a amostra ensaiada.

Vila Nova de Famalicão, **22-4-2020**



O Director dos Laboratórios
Maria Antónia Lopes



CENTRO TECNOLÓGICO DAS INDÚSTRIAS TÊXTIL
E DO VESTUÁRIO DE PORTUGAL
RUA FERNANDO MESQUITA, 2785
4760-034 VILA NOVA DE FAMALICÃO, PORTUGAL

OEKO-TEX®
INSPIRING CONFIDENCE

CERTIFICATE

The company

Estamparia Têxtil Adalberto Pinto da Silva, S.A.
Rua Adalberto Pinto da Silva, 28
4795 - 177 Rebordões - Santo Tirso, PORTUGAL

is granted authorisation according to STANDARD 100 by OEKO-TEX® to use the STANDARD 100 by OEKO-TEX® mark, based on our test report 4133/2020

OEKO-TEX®
CONFIDENCE IN TEXTILES
STANDARD 100



9551CIT CITEVE

Tested for harmful substances
www.oeko-tex.com/standard100



for the following articles:

Reusable community masks, white, dyed or printed, in Polyester/Elastane knitted for mouth and nose protection (model B, level 2) – including articles partially finished with biologically active products accepted by OEKO-TEX® and the following accessories: seam threads, elastics, metallic components, interlinings and non-woven fabrics. (Based on starting materials already STANDARD 100 pre-certified).

The results of the inspection made according to STANDARD 100 by OEKO-TEX®, Appendix 4, **product class II** have shown that the above mentioned goods meet the human-ecological requirements of the STANDARD 100 by OEKO-TEX® presently established in Appendix 4 for products with direct contact to skin.

The certified articles fulfil requirements of Annex XVII of REACH (incl. the use of azo colourants, nickel release, etc.), the American requirement regarding total content of lead in children's articles (CPSIA; with the exception of accessories made from glass) and of the Chinese standard GB 18401:2010 (labelling requirements were not verified).

The holder of the certificate, who has issued a conformity declaration according to ISO 17050-1, is under an obligation to use the STANDARD 100 by OEKO-TEX® mark only in conjunction with products that conform with the sample initially tested. The conformity is verified by audits.

The certificate 9551CIT is valid until 30.04.2021

V. N. de Farnalício, 22.04.2020

P O Director dos Laboratórios
Maria Antónia Lopes

